

35-55V Continuous Input	12V Output	67A Current	784W Power	2000V dc Isolation	Quarter-brick DC-DC Converter
-----------------------------------	----------------------	-----------------------	----------------------	------------------------------	---

The BusQor® BQ55120QZx67 bus converter is a next-generation, board-mountable, isolated, fixed switching frequency DC-DC converter that uses synchronous rectification to achieve extremely high conversion efficiency. The BusQor series provides an isolated step down voltage from 48V to 12 or 9.6V intermediate bus with no regulation in a standard "quarter-brick" module. BusQor converters are ideal for creating the mid-bus voltage required to drive point-of-load (non-isolated) converters in intermediate bus architectures.

BusQor®



BQ55120QZB67 Model

Operational Features

- High efficiency, 97% at full rated load current
- Delivers 67A full power with appropriate derating
- Operating input voltage range: 35-55V
- Fixed frequency switching provides predictable EMI
- No minimum load requirement

Control Features

- On/Off control referenced to input side (negative logic only)
- Inherent current share (by droop method) for high current and parallel applications.

Safety Features

- CAN/CSA C22.2 No. 60950-1
- UL 60950-1
- EN 60950-1

Mechanical Features

- Industry standard quarter-brick pin-out configuration
- Size: 1.51"x 2.34" (38.4 x 59.4mm), height: 0.517" (13.13mm)
- Total Baseplate weight: 2.67 oz (75.7 g)

Protection Features

- Input under-voltage lockout and over-voltage shutdown protects against abnormal input voltages
- Output current limit and short circuit protection (auto recovery)
- Output over-voltage protection
- Thermal shutdown

Contents

Baseplated Mechanical Diagram	2
Electrical Characteristics	3
Compliance & Testing	5
Technical Figures	6
Applications Section	9
Ordering Information	13

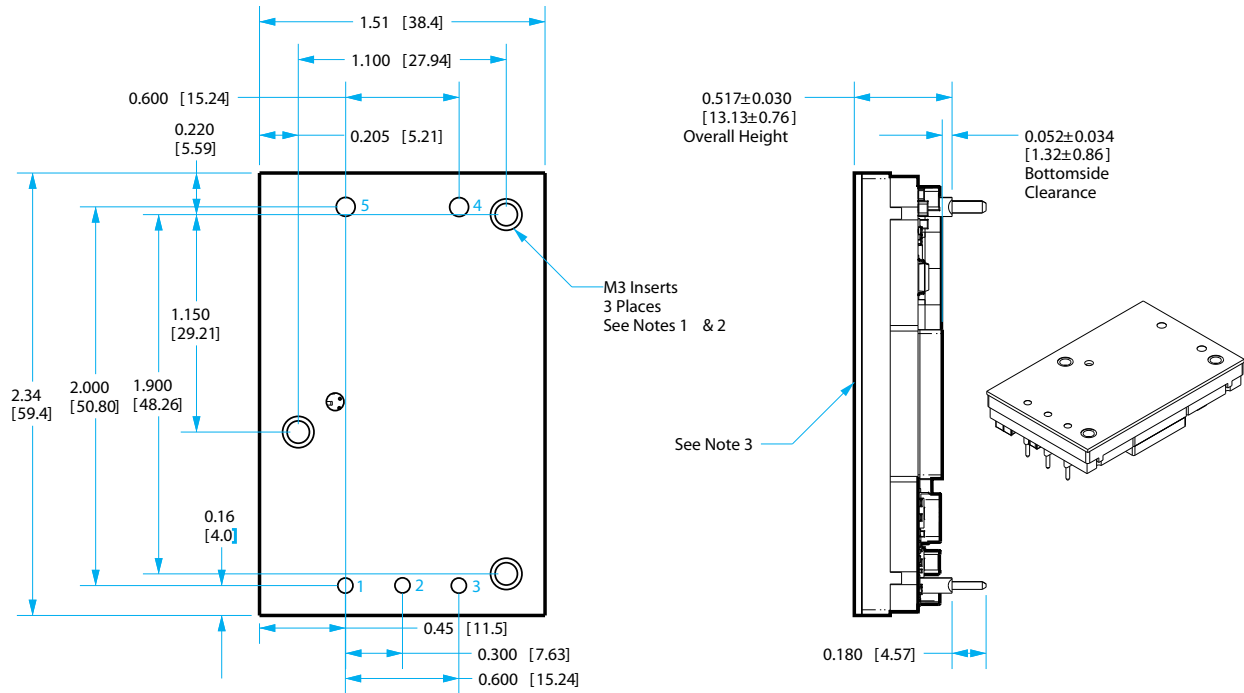

NOTES

- 1) M3 screws used to bolt unit's baseplate to other surfaces such as heatsinks must not exceed 0.10" (2.54mm) depth below the surface of the baseplate.
- 2) Applied torque per screw should not exceed 6in-lb (0.7nm)
- 3) Baseplate flatness tolerance is 0.004" (.10mm) TIR for surface
- 4) Other pin extension lengths available
- 5) Pins 1-3 are 0.040" (1.02mm) dia. with 0.080" (2.03mm) dia. standoff shoulders
- 6) Pins 4 and 5 are 0.062" (1.57mm) dia. with 0.100" (2.54mm) dia. standoff shoulders
- 7) All pins: Material: Copper Alloy
Finish: Matte Tin over Nickel plate
- 8) Undimensioned components are shown for visual reference only
- 9) Baseplate weight: 2.67 oz (75.7 g) typical
- 10) All dimensions in inches(mm)
Tolerances: x.xx in +/-0.02 (x.xmm +/-0.5mm)
x.xxx in +/-0.010 (x.xxmm +/-0.25mm)

PIN DESIGNATIONS

Pin	Name	Function
1	Vin(+)	Positive input voltage
2	ON/OFF	Logic control input to turn converter on/off.
3	Vin(-)	Negative input
4	Vout(-)	Negative output
5	Vout(+)	Positive output



Technical Specification

Input: 35-55V
Output: 12V
Current: 67A
Package: Quarter-brick

BQ55120QZB67 Electrical Characteristics

Ta = 25 °C, airflow rate = 300 LFM, Vin = 48V dc unless otherwise noted; full operating temperature range is -40 °C to +100 °C base plate temperature with appropriate power derating. Specifications subject to change without notice.

Parameter	Min.	Typ.	Max.	Units	Notes & Conditions
ABSOLUTE MAXIMUM RATINGS					
Input Voltage					
Non-Operating	-1		60	V	Continuous
Operating	35		55	V	Continuous
Isolation Voltage					
Input to Output			2000	V	
Operating Temperature	-40		100	°C	
Storage Temperature	-45		125	°C	
Voltage at ON/OFF input pin	-2		18	V	
INPUT CHARACTERISTICS					
Operating Input Voltage Range	35	48	55	V	
Input Under-Voltage Lockout					
Turn-On Voltage Threshold		33.4		V	
Turn-Off Voltage Threshold		31		V	
Lockout Voltage Hysteresis		2.4		V	
Input Over-Voltage Shutdown				V	
Turn-On Voltage Threshold		56.9		V	
Turn-Off Voltage Threshold		59.2		V	
Maximum Input Current			24.5	A	Vin = 35 V
No-Load Input Current			140	mA	
Disabled Input Current		16.0	26.0	mA	
Input Reflected-Ripple Current		25	40	mA	RMS through 10µH inductor
Input Terminal-Ripple Current		300		mA	RMS, full load
Recommended Input Fuse (see Note 1)			30	A	Fast blow external fuse recommended
Recommended External Input Capacitance		47		µF	Typical ESR 0.1-0.2 Ω
Input Filter Component Values (L\C)		0.22\30		µH\µF	Internal values
OUTPUT CHARACTERISTICS					
Output Voltage Set Point		11.8		V	Io = 0 A
Output Voltage Regulation					
Over Line		41.7\5.0		%\V	
Over Load		4.2\500		%\mV	
Over Temperature		1.7\200		%\mV	
Total Output Voltage Range	8.200		13.750	V	Over sample, line, load, temperature & life
Output Voltage Ripple and Noise					20 MHz bandwidth; see Note 2
Peak-to-Peak		125	200	mV	Full load
RMS		40		mV	Full load
Operating Output Current Range	0		67	A	Subject to thermal derating
Output DC Current-Limit Inception		78		A	Output Voltage 10% Low
Output DC Current-Limit Shutdown Voltage		8		V	
Back-Drive Current Limit while Disabled		10		mA	Negative current drawn from output
Maximum Output Capacitance			5,000	µF	12.0 Vout at 33 A Resistive Load
EFFICIENCY					
100% Load		97		%	
50% Load		97		%	

BQ55120QZB67 Electrical Characteristics (continued)

Ta = 25 °C, airflow rate = 300 LFM, Vin = 48V dc unless otherwise noted; full operating temperature range is -40 °C to +100 °C base plate temperature with appropriate power derating. Specifications subject to change without notice.

Parameter	Min.	Typ.	Max.	Units	Notes & Conditions
DYNAMIC CHARACTERISTICS					
Output Voltage during Load Current Transient					
Step Change in Output Current (0.1 A/μs)		150		mV	50% to 75% to 50% Iout max
Settling Time		100		μs	To within 1% Vout nom
Turn-On Transient					
Turn-On Time (with 5mF output capacitance)		5	10	ms	33 A Resistive Load, Vout=90% nom.
Fault Inhibit Time		800		ms	Figure E
Output Voltage Overshoot		0		%	5 mF load capacitance, 33 A Resistive Load
ISOLATION CHARACTERISTICS					
Isolation Voltage (dielectric strength)		2000		V	See Absolute Maximum Ratings
Isolation Resistance		30		MΩ	
Isolation Capacitance (input to output)		1000		pF	See Note 3
Semiconductor Junction Temperature			125	°C	Package rated to 150 °C
Board Temperature			125	°C	UL rated max operating temp 130 °C
Transformer Core Temperature			130	°C	
Base Plate Temperature			100	°C	
FEATURE CHARACTERISTICS					
Switching Frequency	154	175	196	kHz	
ON/OFF Control (Option N)					
On-State Voltage	-1		0.8	V	
Off-State Voltage	2.4		18	V	
ON/OFF Control					Application notes Figures A & B
Pull-Up Voltage		3.3		V	
Pull-Up Resistance		100		kΩ	
Over-Temperature Shutdown OTP Trip Point	140		150	°C	Average PCB Temperature
Over-Temperature Shutdown Restart Hysteresis		10		°C	
RELIABILITY CHARACTERISTICS					
Calculated MTBF (Telcordia) SR-332, Issue 2		5.4		10 ⁶ Hrs.	80% load, 200LFM, 40 °C Ta
Calculated MTBF (MIL-217) MIL-HDBK-217F		3.6		10 ⁶ Hrs.	80% load, 200LFM, 40 °C Ta

Note 1: Safety product certification tests were carried out using 30A fast blow fuse. Fuse interruption characteristics have to be taken into account while designing input traces. User should ensure that Input trace is capable of withstanding fault currents

Note 2: For applications requiring reduced output voltage ripple and noise, consult SynQor applications support (e-mail: support@synqor.com)

Note 3: Isolation capacitance can be added external to the module.



Technical Specification

Input: 35-55V
Output: 12V
Current: 67A
Package: Quarter-brick

Compliance & Testing

Parameter	Notes & Conditions
-----------	--------------------

STANDARDS COMPLIANCE

CAN/CSA C22.2 No. 60950-1

UL 60950-1

EN 60950-1

Note: An external input fuse must always be used to meet these safety requirements. Contact SynQor for official safety certificates on new releases or download from the SynQor website.

Parameter	# Units	Test Conditions
-----------	---------	-----------------

QUALIFICATION TESTING

Life Test	32	95% rated Vin and load, units at derating point, 1000 hours
Vibration	5	10-55 Hz sweep, 0.060" total excursion, 1 min./sweep, 120 sweeps for 3 axis
Mechanical Shock	5	100 g minimum, 2 drops in x, y and z axis
Temperature Cycling	10	-40 °C to 100 °C, unit temp. ramp 15 °C/min., 500 cycles
Power/Thermal Cycling	5	Toperating = min to max, Vin = min to max, full load, 100 cycles
Design Marginality	5	Tmin-10 °C to Tmax+10 °C, 5 °C steps, Vin = min to max, 0-105% load
Humidity	5	85 °C, 85% RH, 1000 hours, continuous Vin applied except 5 min/day
Solderability	15 pins	MIL-STD-883, method 2003

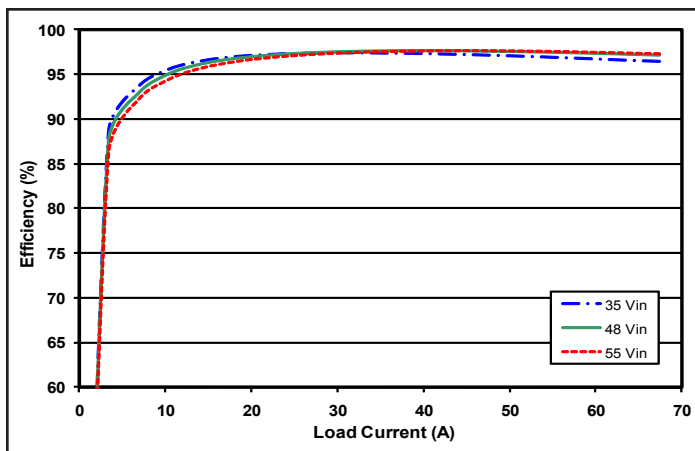

Figure 1: Efficiency at nominal output voltage vs. load current for minimum, nominal, and maximum input voltage at 25°C.

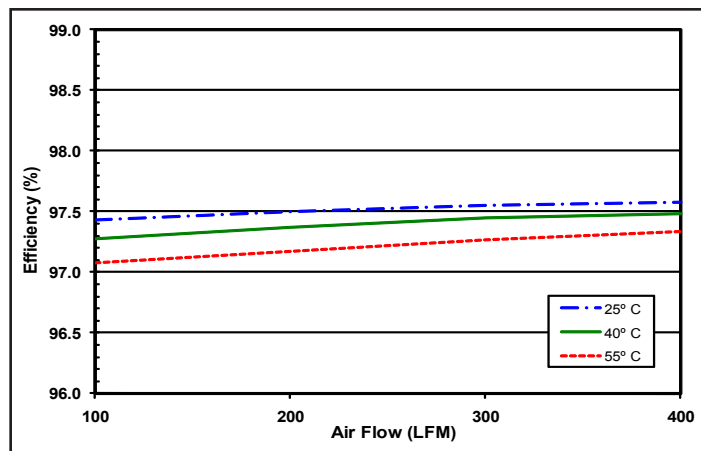

Figure 2: Efficiency at nominal output voltage and 60% rated power vs. airflow rate for ambient air temperatures of 25°C, 40°C, and 55°C (nominal input voltage).

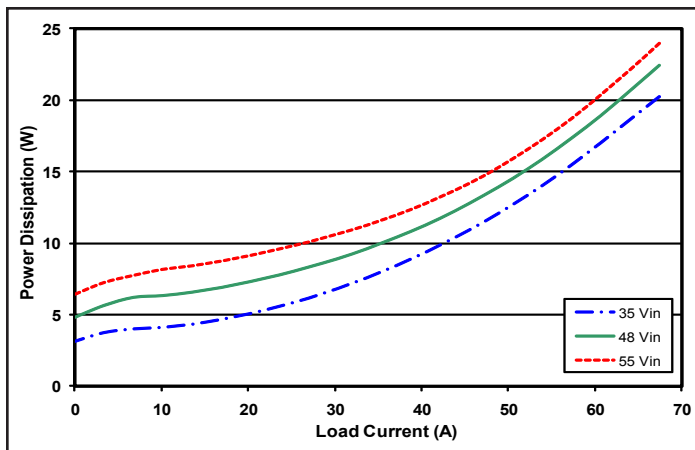

Figure 3: Power dissipation at nominal output voltage vs. load current for minimum, nominal, and maximum input voltage at 25°C.

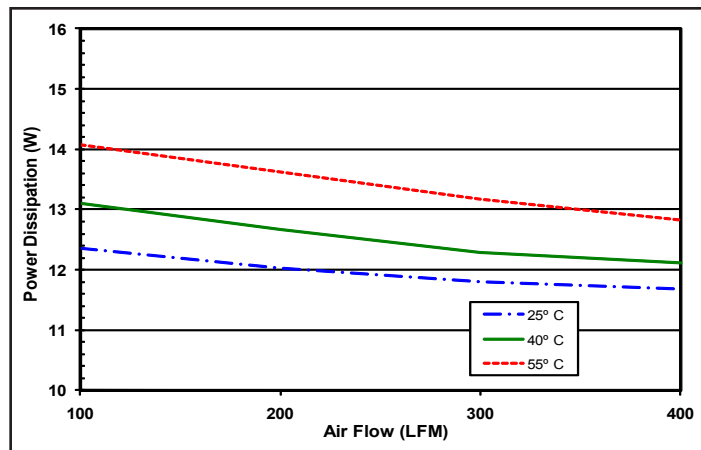

Figure 4: Power dissipation at nominal output voltage and 60% rated power vs. airflow rate for ambient air temperatures of 25°C, 40°C, and 55°C (nominal input voltage).

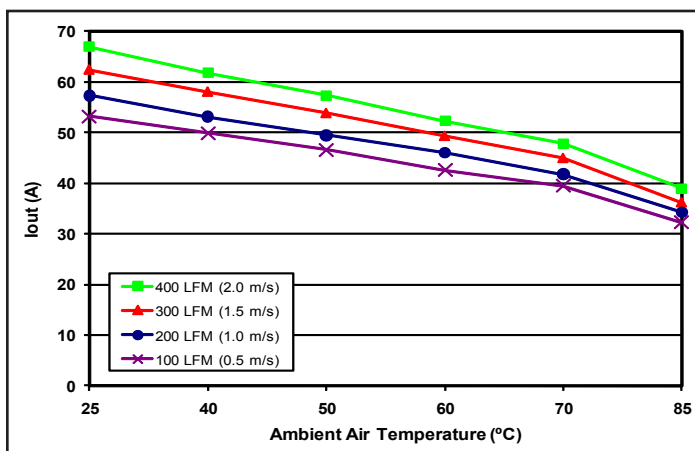

Figure 5: Maximum output current derating curve vs. ambient air temperature (with baseplate only) at different airflow rates with air flowing from output to input (nominal input voltage).

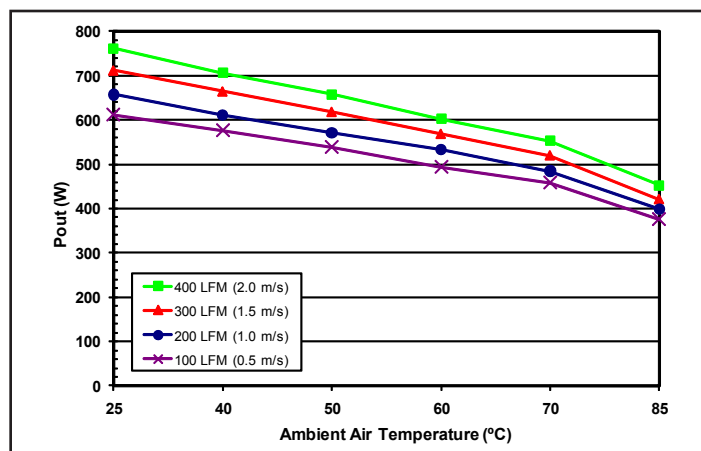

Figure 6: Maximum output power derating curve vs. ambient air temperature (with baseplate only) at different airflow rates with air flowing from output to input (nominal input voltage).

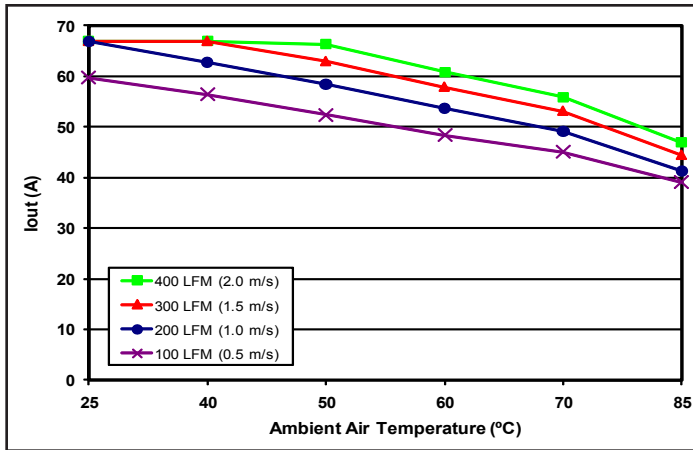

Figure 7: Maximum output current derating curve vs. ambient air temperature (with both baseplate and 0.5" heat sink) at different airflow rates with air flowing from output to input (nominal input voltage).

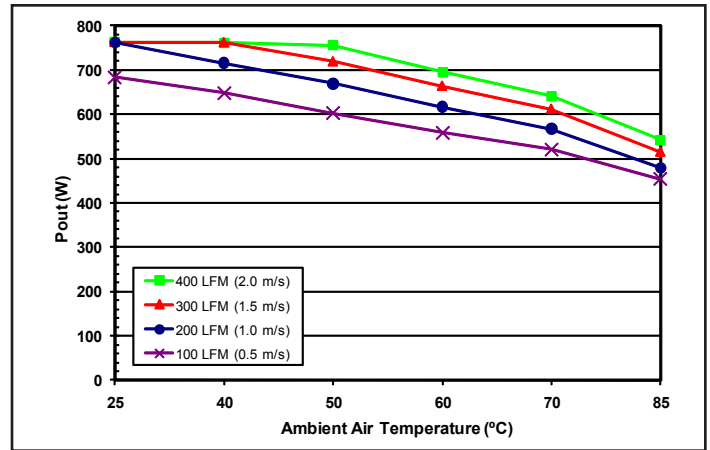

Figure 8: Maximum output power derating curve vs. ambient air temperature (with both baseplate and 0.5" heat sink) at different airflow rates with air flowing from output to input (nominal input voltage).

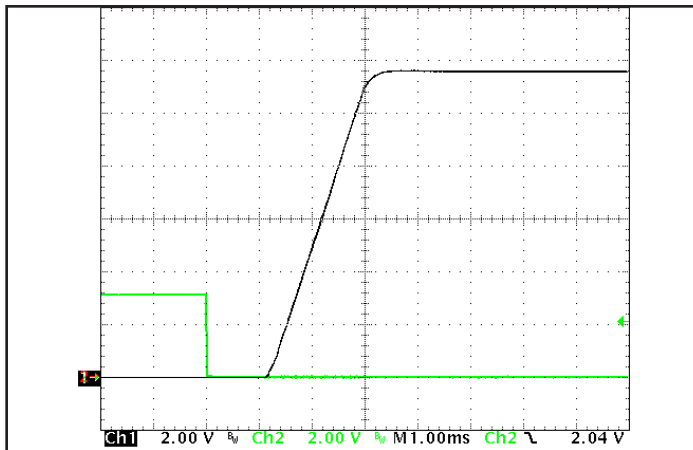

Figure 9: Turn-on transient at half load (resistive load) (1 ms/div). Load cap: 15µF tantalum capacitor and 5mF ceramic capacitor bank. Input voltage pre-applied. Ch 1: V_{out} (2V/div). Ch 2: ON/OFF input (2 V/div).

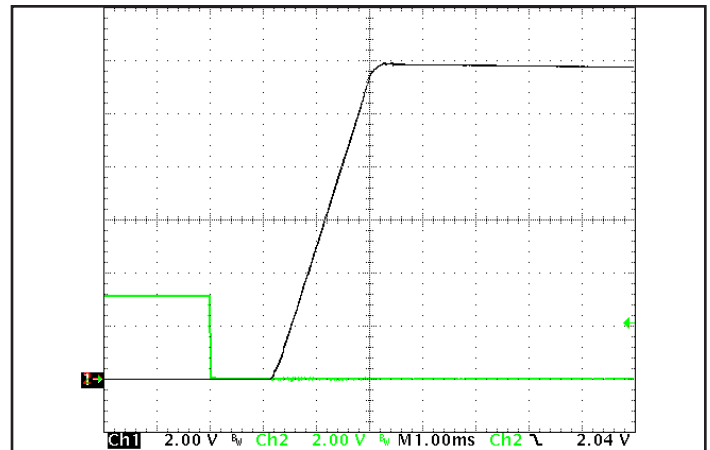

Figure 10: Turn-on transient at zero load (1 ms/div). Load cap: 15µF tantalum capacitor and 5mF ceramic capacitor bank. Ch 1: V_{out} (2V/div), Ch 2: ON/OFF input (2 V/div).

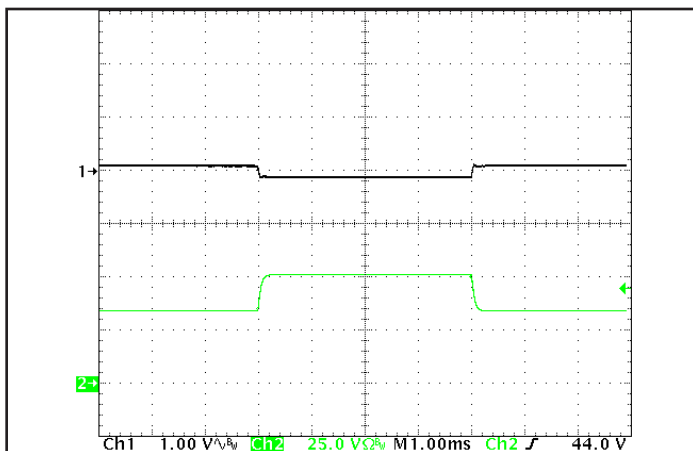

Figure 11: Output voltage response to step-change in load current (50%-75%-50% of $I_{out(max)}$; $dI/dt = 0.1A/\mu s$). Load cap: 15µF tantalum cap and 1µF ceramic cap. Ch 1: V_{out} (1V/div), Ch 2: I_{out} (25A/div).

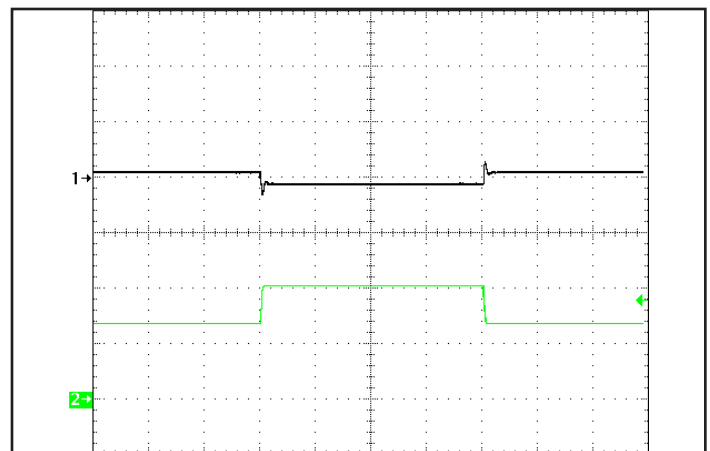

Figure 12: Output voltage response to step-change in load current (50%-75%-50% of $I_{out(max)}$; $dI/dt = 1A/\mu s$). Load cap: 15µF, 30 mΩ ESR tantalum cap and 1µF ceramic cap. Ch 1: V_{out} (1V/div), Ch 2: I_{out} (25A/div).

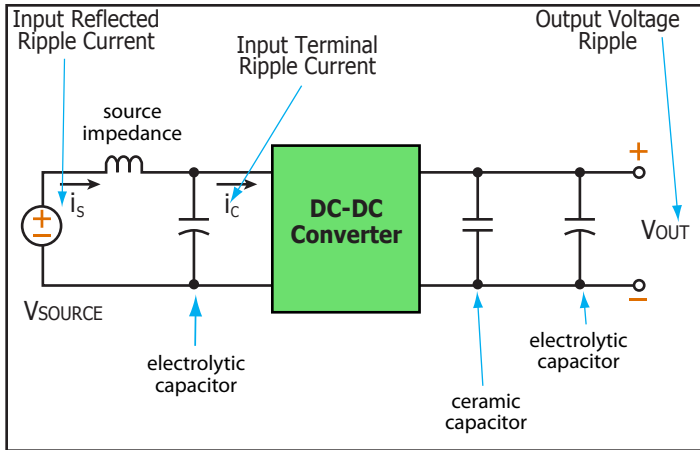

Figure 13: Test set-up diagram showing measurement points for Input Terminal Ripple Current (Figure 14), Input Reflected Ripple Current (Figure 15) and Output Voltage Ripple (Figure 16).

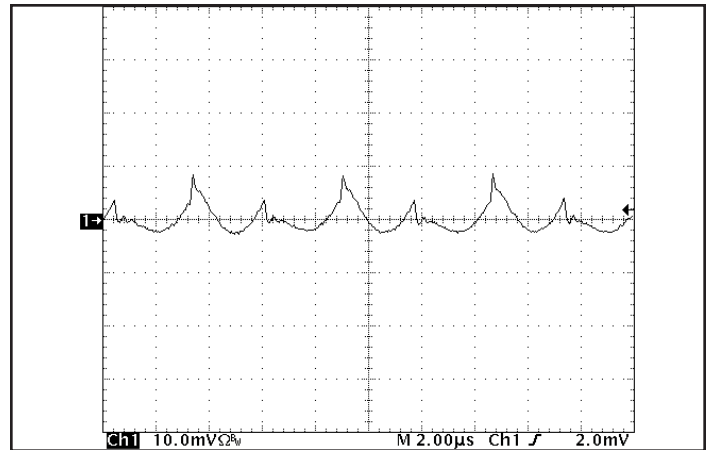

Figure 14: Input Terminal Ripple Current, i_c , at full rated output current and nominal input voltage with $10\mu H$ source impedance and $47\mu F$ electrolytic capacitor (500 mA/div). See Figure 13.

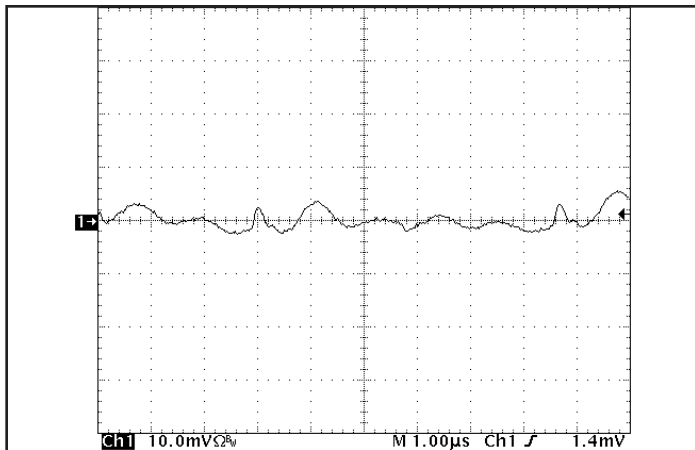

Figure 15: Input reflected ripple current, i_s , through a $10\mu H$ source inductor, using a $47\mu F$ electrolytic input capacitor (20mA/div). See Figure 13.

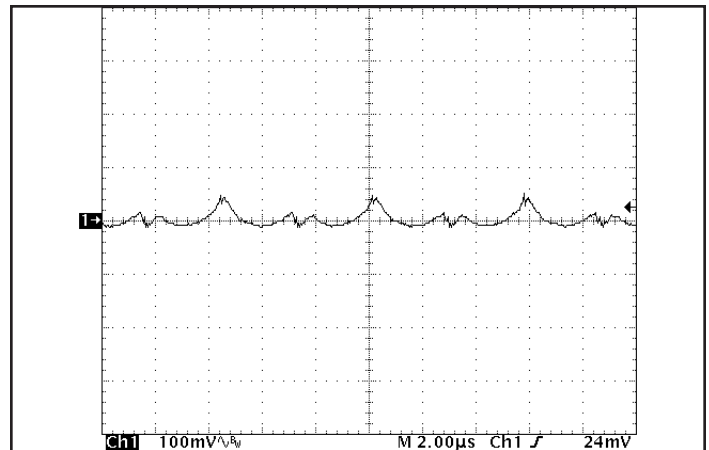

Figure 16: Output voltage ripple at nominal input voltage and rated load current (100mV/div). Load capacitance: $1\mu F$ ceramic capacitor and $15\mu F$ tantalum capacitor. Bandwidth: 20MHz. See Figure 13.

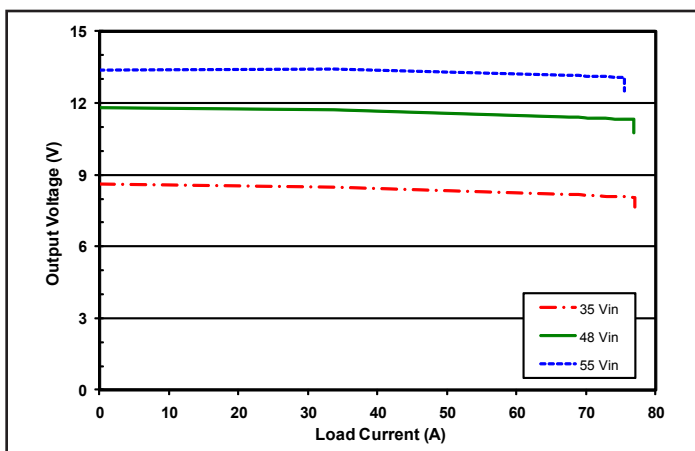

Figure 17: Output voltage vs. load current for different input voltages showing typical current limit curves.

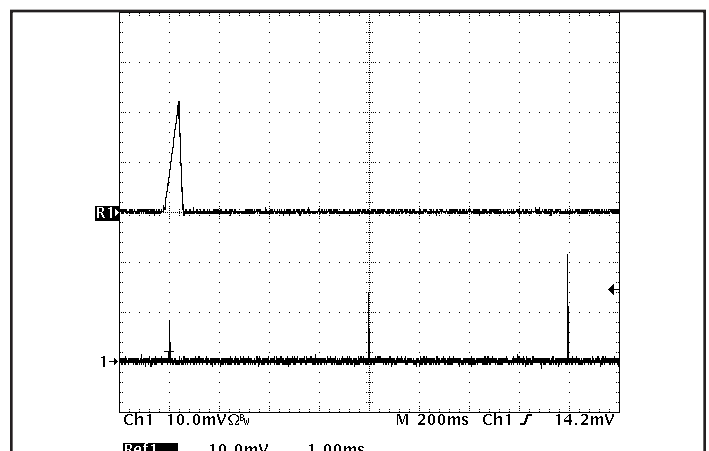

Figure 18: Load current (50A/div) as a function of time when the converter attempts to turn on into a $1m\Omega$ short circuit. Top trace (1ms/div) is an expansion of the on-time portion of the bottom trace.

BASIC OPERATION AND FEATURES

With voltages dropping and currents rising, the economics of an Intermediate Bus Architecture (IBA) are becoming more attractive, especially in systems requiring multiple low voltages. IBA systems separate the role of isolation and voltage scaling from regulation and sensing. The BusQor series bus converter provides isolation and an unregulated voltage step down in one compact module, leaving regulation to simpler, less expensive non-isolated converters.

In Figure A below, the BusQor module provides the isolation stage of the IBA system. The isolated bus then distributes power to the non-isolated buck regulators to generate the required voltage levels at the points of load. In this case, the bucks are represented with SynQor's NiQor series of non-isolated DC/DC converters. In many applications requiring multiple low voltage outputs, significant savings can be achieved in board space and overall system costs.

When designing an IBA system with bus converters, the designer can select from a variety of bus voltages. While there is no universally ideal bus voltage, most designs employ one of the following: 12 V, 9.6 V, 7.5 V, 5 V, or 3.3 V. Higher bus voltages can lead to lower efficiency for the buck regulators but are more efficient for the bus converter and provide lower board level distribution current. Lower bus voltages offer the opposite trade offs.

SynQor's BusQor modules act as a true dc transformer. The output voltage is proportional to the input voltage, with a specified "turns ratio" or voltage ratio, plus minor drop from the internal resistive losses in the module. When used in IBA systems, the output variation of the BusQor must be in accordance with the input voltage range of the non-isolated converters being employed.

The BusQor architecture is very scalable, meaning multiple bus converters can be connected directly in parallel to allow current sharing for higher power applications.

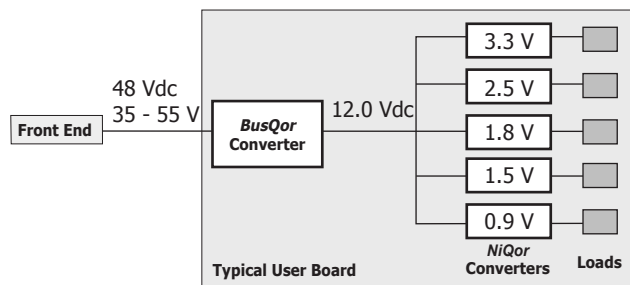

Figure A: Example of Intermediate Bus Architecture using BusQor bus converter and NiQor non-isolated converters

CONTROL FEATURES

REMOTE ON/OFF (Pin 2): The ON/OFF input, Pin 2, permits the user to control when the converter is on or off. This input is referenced to the return terminal of the input bus, Vin(-).

In the negative logic version, the ON/OFF signal is active low (meaning that a low turns the converter on). Figure B is a detailed look of the internal ON/OFF circuitry.

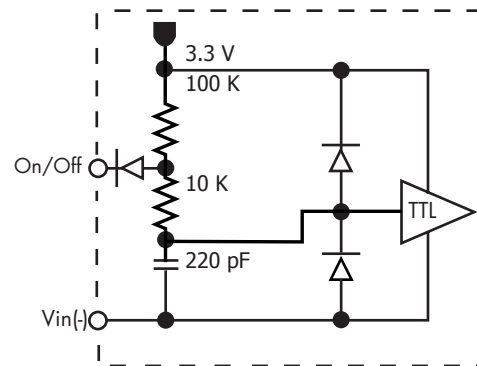

Figure B: Internal ON/OFF pin circuitry

PROTECTION FEATURES

Input Under-Voltage Lockout: The converter is designed to turn off when the input voltage is too low, helping avoid an input system instability problem, described in more detail in the application note titled "Input System Instability". The lockout circuitry is a comparator with DC hysteresis. When the input voltage is rising, it must exceed the typical Turn-On Voltage Threshold value (listed on the specification page) before the converter will turn on. Once the converter is on, the input voltage must fall below the typical Turn-Off Voltage Threshold value before the converter will turn off. Also see Figure E.

Output Current Limit: The output of the BusQor module is electronically protected against output overloads. When an overload current greater than the "DC Current-Limit Inception" specification is drawn from the output, the output shuts down to zero volt after a typical period of 1 ms (see Figure C). The converter remains in the off state for ~ 800 ms (Figure D) after which the BusQor tries to power up again (10 ms). If the overload persists, the output voltage will go through repeated cycles of shutdown and restart with a duty cycle of 1.25% (On) and 98.75% (Off) respectively. The BusQor module returns (auto resetting) to normal operation once the overload is removed. The BusQor is designed to survive in this mode indefinitely without damage and without human intervention.

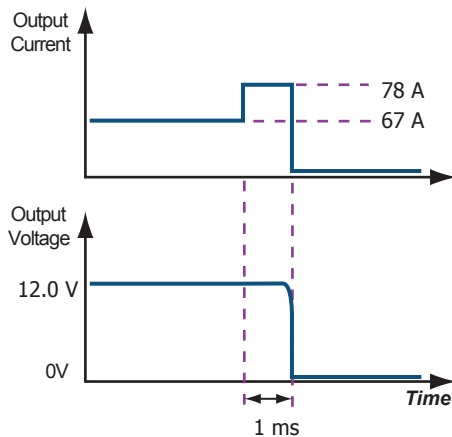

Figure C: Output Overload protection diagram (not to scale)

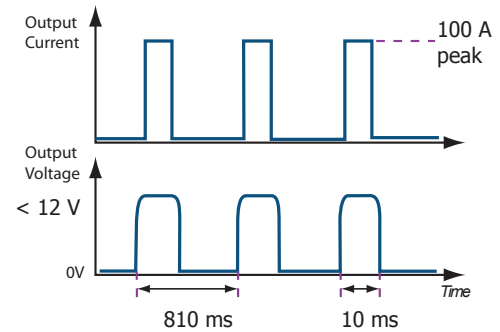

Figure D: Output Short Circuit and Auto-Resetting protection diagram (not to scale)

Output Short Circuit Protection: When the output of the BusQor module is shorted, a peak current of typically 100 A will flow into the short circuit for a period of about 0.5 ms. The output of the BusQor will shutdown to zero for ~ 800 ms (Figure D). At the end of the shutdown period the BusQor module tries to restart. If the short circuit persists, the output voltage will go through repeated cycles of shutdown and restart. The BusQor module returns (auto resetting) to normal operation once the short circuit is removed. The BusQor is designed to survive in this mode indefinitely without damage and without human intervention.

In the Auto resetting mode, also referred to as "Hiccup" mode, the power drawn from the 48 V input is about 5 Watts, most of which is dissipated into the external fault. It is important that copper traces and pads from the output circuit be designed to withstand the short term peaks, although the average current into the fault may be as low as 0.1 A typical. See Figure 18 for appropriate waveform.

Over-Temperature Shutdown: A temperature sensor on the converter senses the average temperature of the module. The thermal shutdown circuit is designed to turn the converter off when the temperature at the sensed location reaches the Over-Temperature Shutdown value. It will allow the converter to turn on again when the temperature of the sensed location falls by the amount of the Over-Temperature Shutdown Restart Hysteresis value.

APPLICATION CONSIDERATIONS

Start-up Considerations: When powering-up, the module must charge all its load capacitance. If a load is present during power-up, then in addition to charging the output capacitance the module must also deliver energy to that load. If the load is resistive then the power to the load will incrementally increase as the output voltage increases. However, if the load is constant-current then the load will be fully applied from a low output voltage. Therefore the constant-current load requires more energy at power-up. The simultaneous charging of the output capacitance while delivering power to a load can slow down the rise of output voltage of the module. This delay to full power-up may appear to the module as a load fault. That appearance of a load fault will cause the module to shut down and then attempt to re-start after a delay. To avoid this condition and ensure a successful start-up, at power-up the module load should be half or less of the rated power, and the load should be resistive.

Start-Up Inhibit Period: Figure E details the Start-Up Inhibit Period for the BusQor module. At time t_0 , when V_{in} is applied with On/Off pin asserted (enabled), the BusQor output begins to build up. Before time t_1 , when the input voltage is below the UVL threshold, the unit is disabled by the Input Under-Voltage Lockout feature. When the input voltage rises above the UVL threshold, the Input Under-Voltage Lockout is released, and a typical Startup Inhibit Period of 12 ms is initiated. The output builds up to 90% of the nominal value of 12.0 V in a period of 5 ms typical (50% load).

At time t_2 , when the On/Off pin is de-asserted (disabled), the BusQor output instantly drops to 0V. Fall time from 12.0 V to 0 V is dependent on output capacitance and any parasitic trace inductance in the output load circuit.

At time t_3 , when the On/Off pin is re-asserted (enabled), the BusQor module output begins to build up after the inhibit period of 800 ms typical has elapsed.

Refer to the Control Features section of the data sheet for details on enabling and disabling methods for Bus Qor modules.

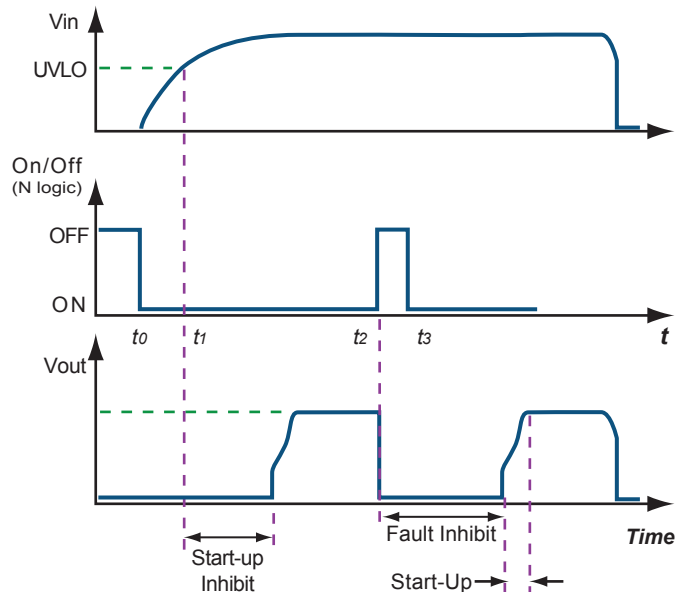

Figure E: Power Up/Down Diagram showing Start-Up Inhibit Period (not to scale)

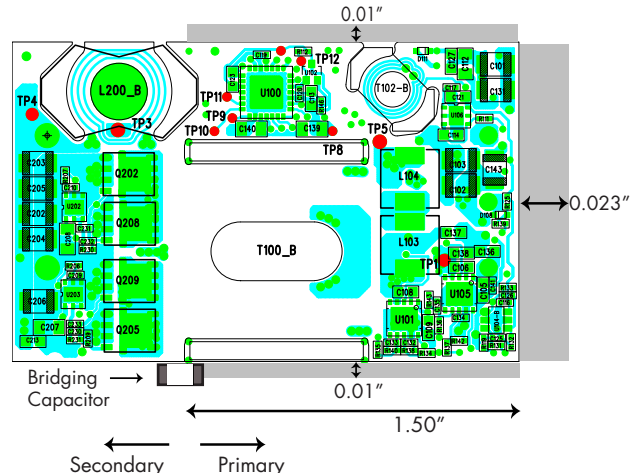

Figure F: Keep Out Areas for BusQor module (view from bottom)

Component Keep Out Area: Keep out areas for components not referenced to the Primary circuit are shown in shaded areas in Figure F. The keep out areas shown are consistent with UL's requirements for Basic Insulation of 0.04" (40 mils) for Pollution degree 2. User should consult UL standards for other insulation classes and operating environments. For applications that require mounting parts BELOW the BusQor module, one should be aware of potential high levels of electromagnetic interference, in addition to safety keep out. Users are advised to consult SynQor Applications engineering in such applications.

Copper Keep Out Area: Keep out areas shown in Figure F are to be observed for Top layer copper traces and vias. Internal layers buried one or more layers may be exempt, depending on the PCB material grade and thickness. Users are advised to consult UL standards for details.

All layers including top and bottom, are subject to the keep out areas shown around Primary pins of BusQor module. Actual keep outs along the surface (Creepage) may vary depending on the PCB material CTI. Users are advised to consult UL standards for details.

Bridging Components: Bridging components like EMI filter capacitors required to be placed as close as possible to the BusQor module for optimum performance must observe the clearance/creepage requirements of 0.04" (40 mils) between pads to maintain compliance to UL standards for the overall power system.

Note: Referenced keep out widths are adequate to withstand UL's Basic Insulation Dielectric strength tests for approved PCB materials. Applications requiring Double or Reinforced insulation must double the keep out widths shown in Figure F. Keep out areas shown have standard margins above UL's minimum requirements.

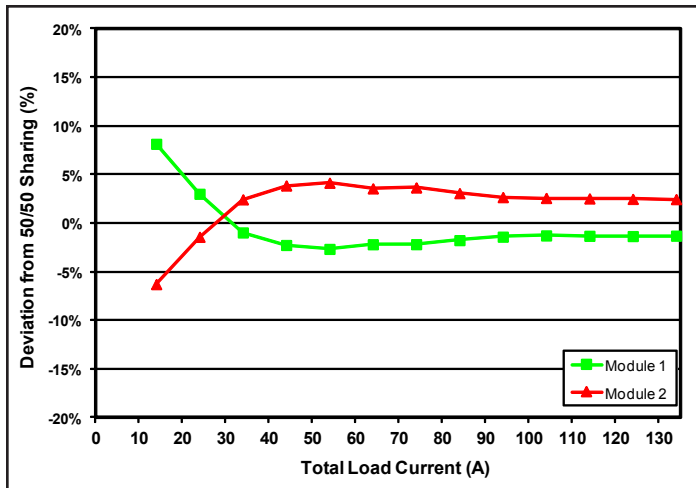

Figure G: Current share performance of 2 paralleled modules

Current Sharing: BusQor modules are designed to operate in parallel without the use of any external current share circuitry. Current share is achieved through "droop share". An output capacitor is recommended across each module located close to the converter for optimum filtering and noise control performance. Dedicated input inductors are recommended but are considered optional. Input capacitors must be located close to the converter module. PCB layout in the input circuit should be such that high frequency ripple currents of each module is restricted to a loop formed by the input capacitors and the input terminals of the BusQor module. See Figure H for details on PCB layout. If needed, please contact SynQor application engineering for further assistance on PCB trace design.

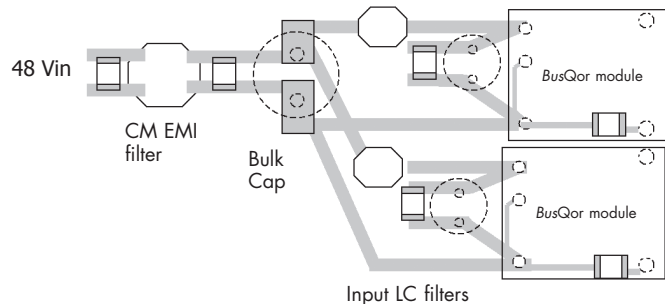

Figure H: Recommended PCB layout for input circuit

The typical current share performance of two paralleled modules is illustrated in the graph shown in Figure G. In this graph the percent deviation from ideal sharing (50%) is plotted for each module versus the total output load current at 48Vin. Since current sharing is achieved through droop share, the system board impedances (non common impedances) can affect the overall sharing performance. For additional assistance in implementing current sharing please consult the application note titled "Paralleling Capability of SynQor Converters" and / or consult SynQor application engineering.



Ordering Information

Input: 35-55V
Output: 12V
Current: 67A
Package: Quarter-brick

Part Numbering System

The part numbering system for SynQor's dc-dc converters follows the format shown in the example below.

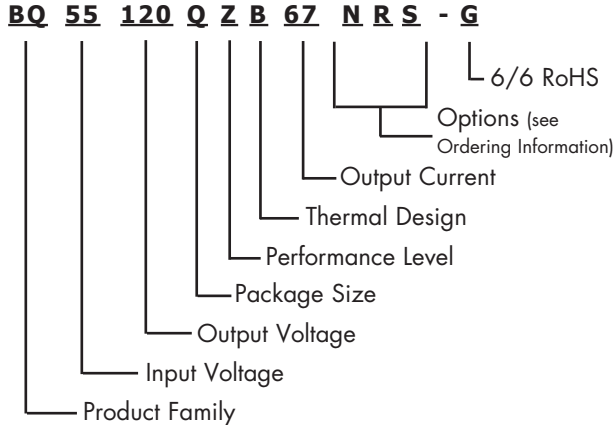

The first 12 characters comprise the base part number and the last 3 characters indicate available options. The "-G" suffix indicates 6/6 RoHS compliance.

Application Notes

A variety of application notes and technical white papers can be downloaded in pdf format from our [website](#).

RoHS Compliance: The EU led RoHS (Restriction of Hazardous Substances) Directive bans the use of Lead, Cadmium, Hexavalent Chromium, Mercury, Polybrominated Biphenyls (PBB), and Polybrominated Diphenyl Ether (PBDE) in Electrical and Electronic Equipment. This SynQor product is 6/6 RoHS compliant. For more information please refer to SynQor's RoHS addendum available at our [RoHS Compliance / Lead Free Initiative web page](#) or e-mail us at rohs@synqor.com.

Contact SynQor for further information and to order:

Phone: 978-849-0600 Toll Free: 888-567-9596 Fax: 978-849-0602

E-mail: power@synqor.com Web: www.synqor.com

Address: 155 Swanson Road, Boxborough, MA 01719 USA

WARRANTY

SynQor offers a three (3) year limited warranty. Complete warranty information is listed on our website or is available upon request from SynQor.

Ordering Information

The tables below show the valid model numbers and ordering options for converters in this product family. When ordering SynQor converters, please ensure that you use the complete 15 character part number consisting of the 12 character base part number and the additional characters for options. Add "-G" to the model number for 6/6 RoHS compliance.

Model Number	Input Voltage	Output Voltage	Max Output Current
BQ55120QZB67xyz-G	35-55V	12V	67A

The following options must be included in place of the **wxyz** spaces in the model numbers listed above.

Options Description: w x y z			
Thermal Design	Enable Logic	Pin Style	Feature Set
B - Baseplated	N - Negative	N - 0.145" R - 0.180"	S - Standard

Not all combinations make valid part numbers, please contact SynQor for availability.

PATENTS

SynQor holds numerous U.S. patents, one or more of which apply to most of its power conversion products. Any that apply to the product(s) listed in this document are identified by markings on the product(s) or on internal components of the product(s) in accordance with U.S. patent laws. SynQor's patents include the following:

7,050,309 7,765,687 7,787,261
8,149,597 8,644,027